

SMART JOINT

SMART SERIES STRAIGHT COUPLINGS

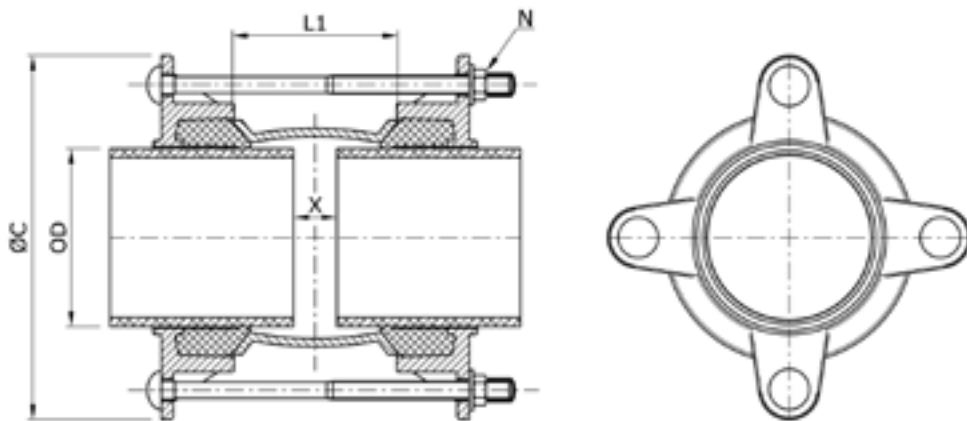

DN	ØD		L1	ØC	Bolts Quantity	Gap X		Weight
	Min.	Max.				Max	Min.	
50	58	74	102	170	4	40	12	3.0
65	68	84		183				3.6
80	84	105		210				5.0
100	99	118		223				5.4
	109	133		244				6.0
125	133	157	268	6.7				
150	157	182	118	296		9.5		
	177	201		314		9.8		
200	194	215		140		322		10.3
	218	242	354			13.5		
225	242	268	403		16.3			
250	266	291	162		405	17.4		
	280	305		424	19.0			
300	302	327		443	20.0			

The data concerning the min. and max. gap is calculated on the minimum outside diameter of the product's range

NOTES

